

SERIE 500

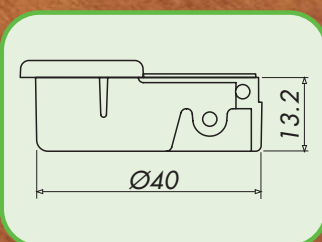

Copertura in metallo
Art. 06AI089----1
Metal cover cap
Art. 06AI089----1

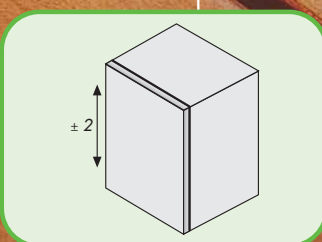
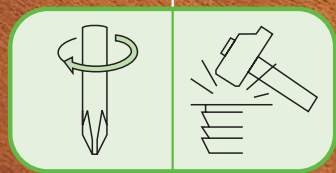
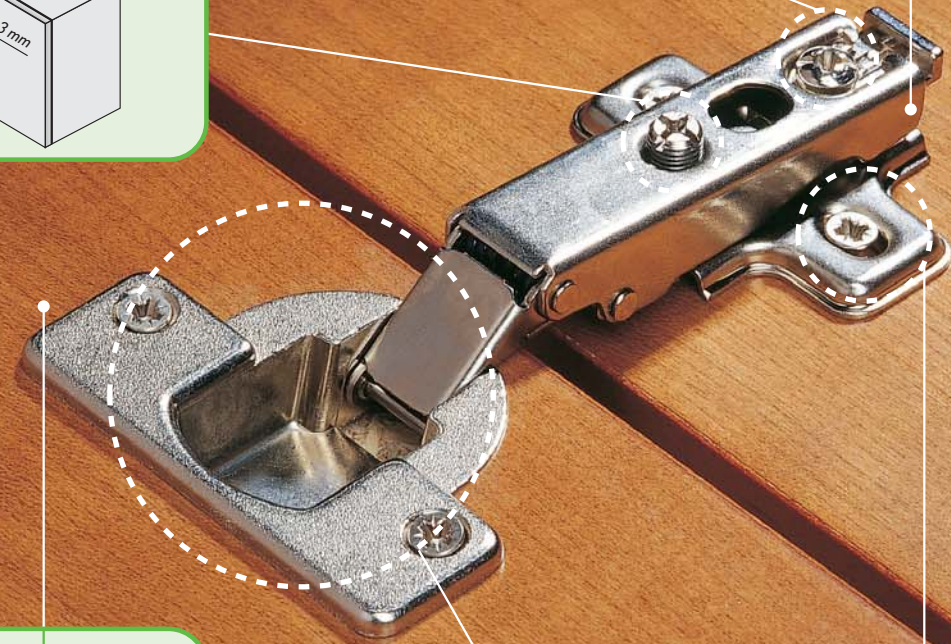
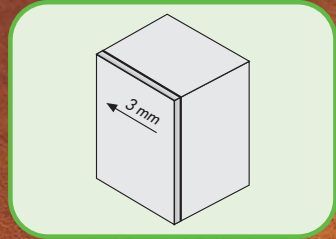
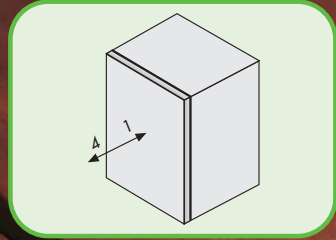
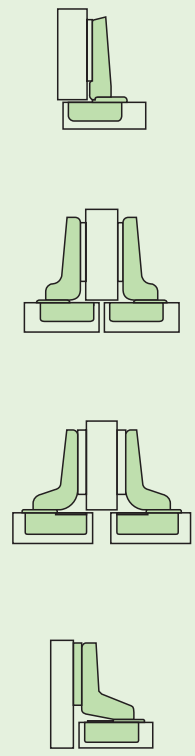

Copertura in plastica
Art. 2NY22 solo per
cerniere ad aggancio rapido
Plastic cover cap
Art. 2NY22 for fast assembling
hinge only

2500	fino a 20 Kg.
2000	fino a 16 Kg.
1600	fino a 13 Kg.
900	fino a 7 Kg.
600	

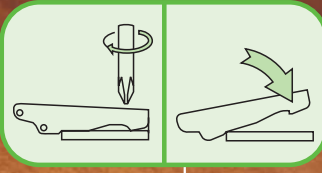
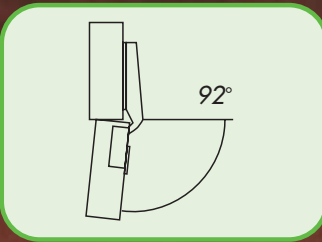

1 BRACCIO COLLO BASSO OVERLAY DOOR

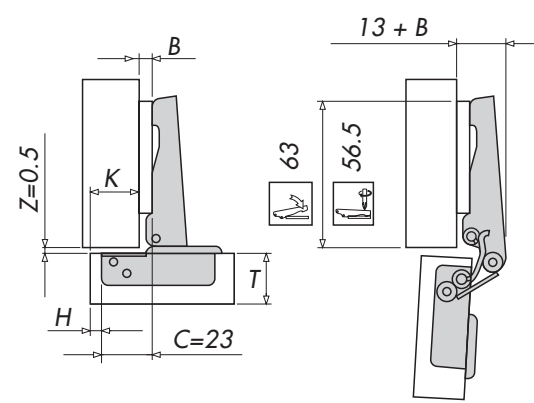

B	3	4	5	6	7	8	9	10	11	12	H
2	24	25	26	27	28	29	30	31	32	33	
3	23	24	25	26	27	28	29	30	31	32	
4	4	22	23	24	25	26	27	28	29	30	31
6	6	20	21	22	23	24	25	26	27	28	29
8	8	18	19	20	21	22	23	24	25	26	27
10	16	17	18	19	20	21	22	23	24	25	
14	12	13	14	15	16	17	18	19	20	21	

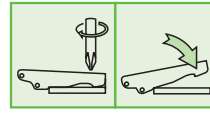

2 BRACCIO COLLO MEDIO HALF OVERLAY DOOR

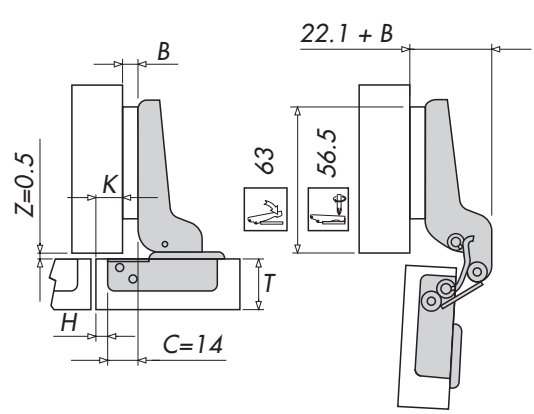

B	3	4	5	6	7	8	9	10	11	12	H
2	15	16	17	18	19	20	21	22	23	24	
3	14	15	16	17	18	19	20	21	22	23	
4	4	13	14	15	16	17	18	19	20	21	22
6	6	11	12	13	14	15	16	17	18	19	20
8	8	9	10	11	12	13	14	15	16	17	18
10	7	8	9	10	11	12	13	14	15	16	
14	3	4	5	6	7	8	9	10	11	12	

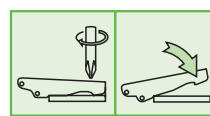

3 BRACCIO COLLO MEDIO ALTO HALF OVERLAY DOOR

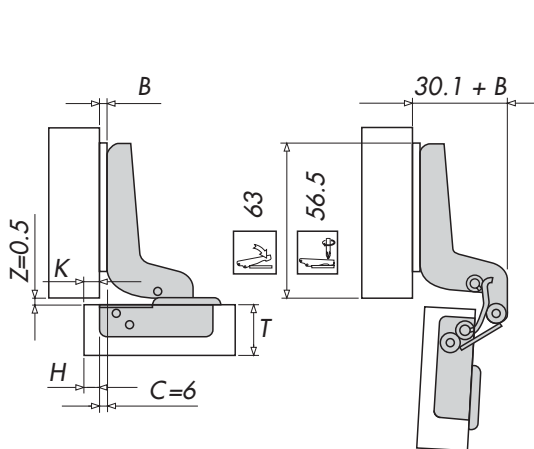

B	3	4	5	6	7	8	9	10	11	12	H
2	7	8	9	10	11	12	13	14	15	16	
3	6	7	8	9	10	11	12	13	14	15	
4	4	5	6	7	8	9	10	11	12	13	14
6	6	3	4	5	6	7	8	9	10	11	12
8	8	1	2	3	4	5	6	7	8	9	10
10	-1	0	1	2	3	4	5	6	7	8	
14		-3	-2	-1	0	1	2	3	4		

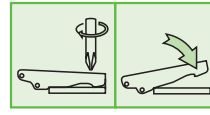

Basi per serie 500 da pag. 71 a 75
Mounting plates for series 500 from page 71 to 75



7 BRACCIO COLLO ALTO

INSET DOOR

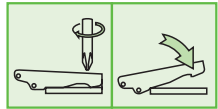
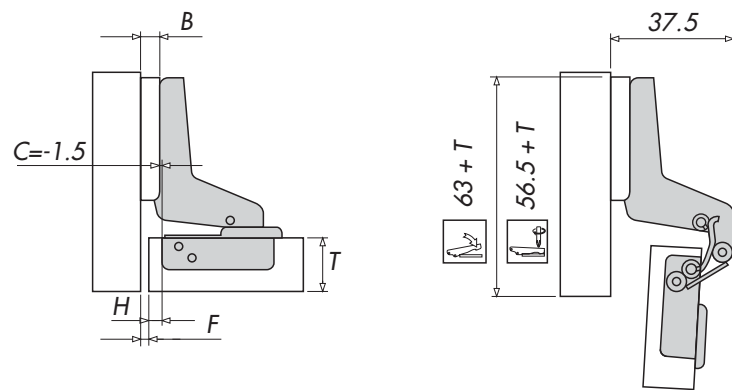

B	3		4		5		6		7		8		9		10		11		12		13		14		H	T
	≤ 20	≤ 28	≤ 24	≤ 31	≤ 34	≤ 18	≤ 29	≤ 33	≤ 24	≤ 32	≤ 35	≤ 19	≤ 29	≤ 35	≤ 25	≤ 32	≤ 19	≤ 29	≤ 25	≤ 36	≤ 19	≤ 36	≤ 33	≤ 30		
2	0.5																									
3	1.5																									
4		2.5	1.5			0.5																				
4	6			3.5		2.5		1.5		0.5																
8				5.5		4.5		3.5		2.5	1.5	0.5														
1								5.5		4.5	3.5	2.5	1.5	0.5												
0															5.5	4.5	3.5	2.5	1.5							

H	T	24	25	26	27	28	29	30	31	32	33	34	35
		3	1.5	1.7	1.9	2.2	2.4	2.7	3.0	3.5	4.4	5.4	6.4
4	1.5	1.7	1.9	2.1	2.4	2.6	2.9	3.2	3.7	4.6	5.6	6.6	
5	1.4	1.6	1.9	2.1	2.3	2.6	2.9	3.2	3.5	4.1	4.9	5.9	
6	1.4	1.6	1.8	2.1	2.3	2.6	2.8	3.1	3.4	3.7	4.4	5.3	
7	1.4	1.6	1.8	2.0	2.3	2.5	2.8	3.1	3.4	3.7	4.0	4.7	
8	1.4	1.6	1.8	2.0	2.3	2.5	2.8	3.0	3.3	3.6	4.0	4.3	
9	1.4	1.5	1.8	2.0	2.2	2.5	2.7	3.0	3.3	3.6	3.9	4.2	
10	1.3	1.5	1.7	2.0	2.2	2.4	2.7	3.0	3.2	3.5	3.8	4.2	
11	1.3	1.5	1.7	1.9	2.2	2.4	2.7	2.9	3.2	3.5	3.8	4.1	
12	1.3	1.5	1.7	1.9	2.1	2.4	2.6	2.9	3.1	3.4	3.7	4.1	
13	1.3	1.5	1.7	1.9	2.1	2.3	2.6	2.8	3.1	3.4	3.7	4.0	
14	1.3	1.5	1.6	1.9	2.1	2.3	2.6	2.8	3.1	3.4	3.7	4.0	
15	1.3	1.4	1.6	1.8	2.0	2.3	2.5	2.8	3.0	3.3	3.6	3.9	

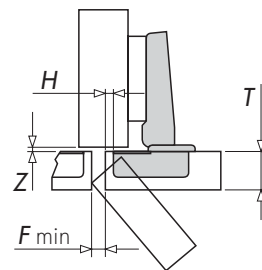
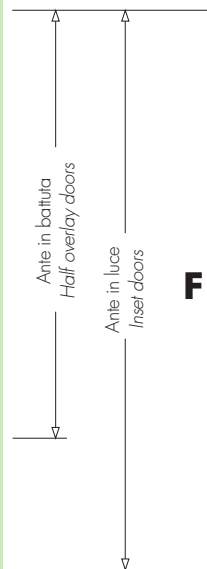

- Tabella per la determinazione di "F" in funzione dello spessore "T" e della distanza "H" mantenendo costante Z = 0.5 mm
- Schedule to determine "F" according to door thickness "T" and distance "H" keeping constant Z = 0.5 mm

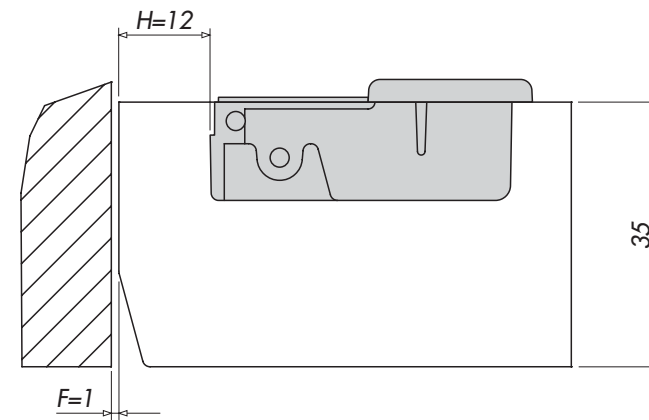

- Sezione massima dell'anta con una fuga (F) = 1 mm e una foratura (H) a 12 mm dal bordo.
- Maximum door section with opening clearance (F) = 1 mm and boring distance (H) 12 mm from door edge.

3 FISSAGGIO A VITE

SCREW-ON FIXING

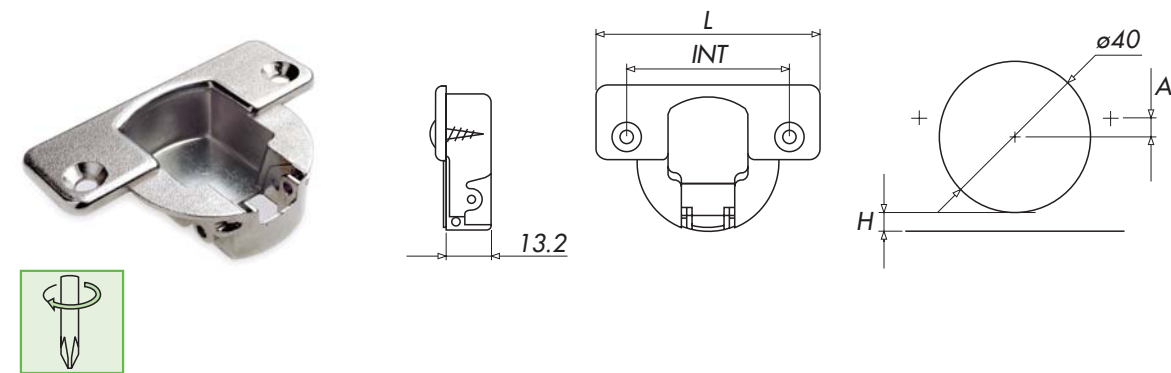

INT.	A	L
52	7.5	66

3/2 FISSAGGIO A PRESSIONE

KNOCK-IN FIXING

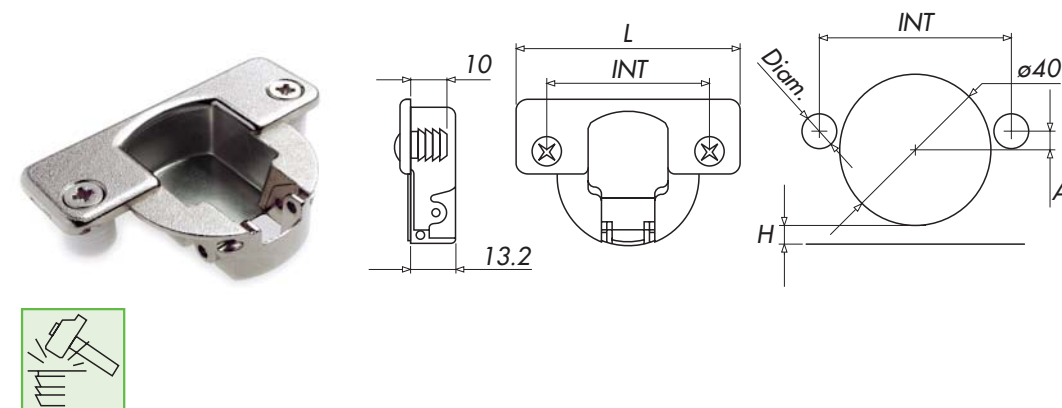

INT.	A	DIAM.	L
52	7.5	10	66

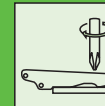

SERIE 500		3		3/2	
1			Nichel	501310	501310/2
			Pz./Kg	250/17.1	250/17.8
2			Nichel	501310C	501310/2C
			Pz./Kg	250/20.4	250/21.1
3			Nichel	502310	502310/2
			Pz./Kg	250/17.4	250/18.1
7			Nichel	503310	503310/2
			Pz./Kg	250/18.1	250/18.8
3			Nichel	503310C	503310/2C
			Pz./Kg	250/21.4	250/22.1
7			Nichel	507310	507310/2
			Pz./Kg	200/15.9	200/16.6
3			Nichel	507310C	507310/2C
			Pz./Kg	200/18.5	200/19.2

9929/LR

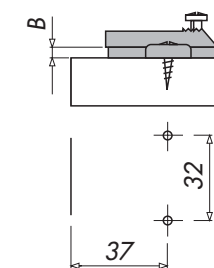

B	Cod. Art.	Conf. N° pezzi	Peso Kg	Mater.
2	992912/LR	1000	18	acciaio steel
4	992914/LR	1000	18.5	acciaio steel
6	992916/LR	1000	19.5	acciaio steel
8	992918/LR	500	10.5	acciaio steel
10	9929110/R	500	14	zama zamak
14	9929114/R	500	16	zama zamak

9929/LRO

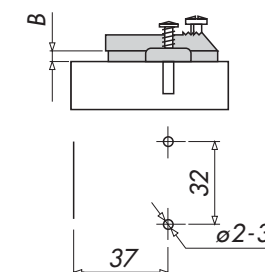
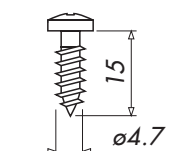
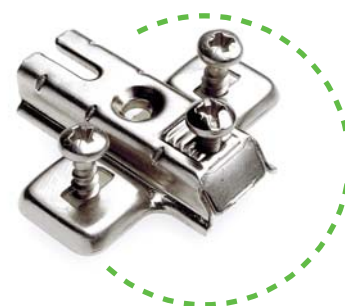

B	Cod. Art.	Conf. N° pezzi	Peso Kg	Mater.
2	992912/LRO	500	11	acciaio steel
4	992914/LRO	500	11.5	acciaio steel
6	992916/LRO	500	12	acciaio steel
8	992918/LRO	500	12.5	acciaio steel
10	9929110/RO	500	16	zama zamak
14	9929114/RO	500	17	zama zamak

9929/LE

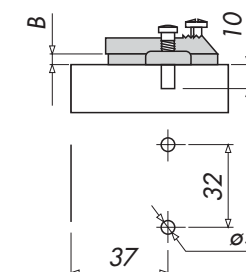
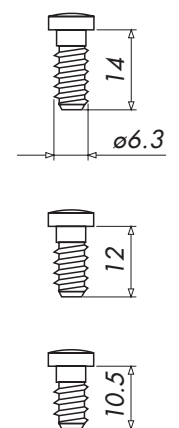
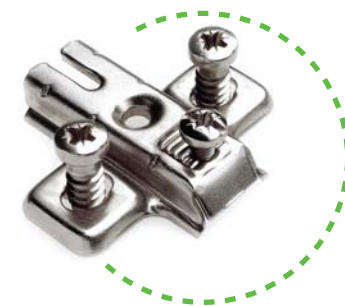

- Le basi standard sono fornite con le viti $\varnothing 6.3 \times 14$. A richiesta sono disponibili anche con le viti altezza 12 e 10.5 mm.
- Standard mounting plates are supplied with diam. $\varnothing 6.3 \times 14$ screws. On request we can also supply them with the 12 and 10.5 mm high screws.

B	Cod. Art.	Conf. N° pezzi	Peso Kg	Mater.
2	992912/LE	500	12	acciaio steel
4	992914/LE	500	12.5	acciaio steel
6	992916/LE	500	13	acciaio steel
8	992918/LE	500	13.5	acciaio steel
10	9929110/E	500	18	zama zamak
14	9929114/E	500	14	zama zamak

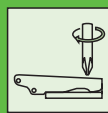

9929/LR5

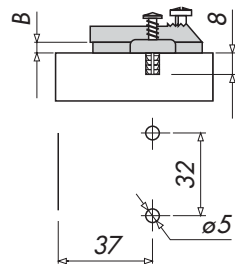
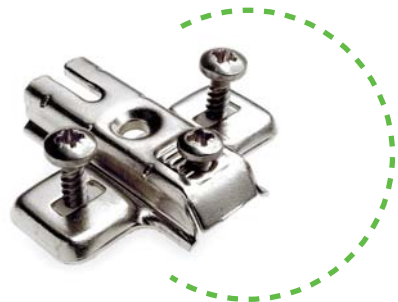

B	Cod. Art.	Conf. N° pezzi	Peso Kg	Mater.
2	992912/LR5	500	11	acciaio steel
4	992914/LR5	500	11.5	acciaio steel
6	992916/LR5	500	12	acciaio steel
8	992918/LR5	500	12.5	acciaio steel
10	9929110/R5	500	16	zama zamak
14	9929114/R5	500	17	zama zamak

9929/LR10

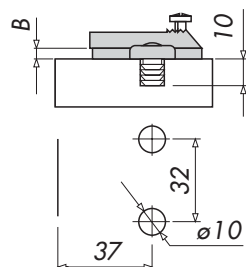

B	Cod. Art.	Conf. N° pezzi	Peso Kg	Mater.
2	992912/LR10	500	12	acciaio steel
4	992914/LR10	500	12.5	acciaio steel
6	992916/LR10	500	13	acciaio steel
8	992918/LR10	500	13	acciaio steel
10	9929110/R10	500	16.5	zama zamak
14	9929114/R10	500	17.5	zama zamak

9931/LR

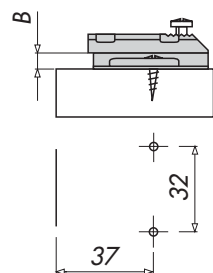

B	Cod. Art.	Conf. N° pezzi	Peso Kg	Mater.
4	993114/LR	500	16	acciaio steel
6	993116/LR	500	16.2	acciaio steel
8	993118/LR	500	16.5	acciaio steel

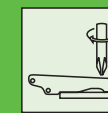

9931/LE

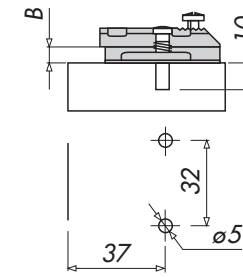
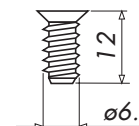

B	Cod. Art.	Conf. N° pezzi	Peso Kg	Mater.
4	993114/LE	500	18.5	acciaio steel
6	993116/LE	500	18.7	acciaio steel
8	993118/LE	500	19	acciaio steel

9922/R

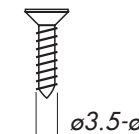

Vite non inclusa
Screw not included

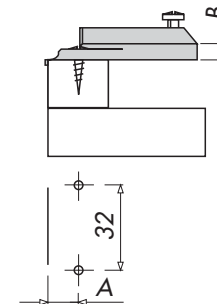

A	B	Cod. Art.	Conf. N° pezzi	Peso Kg	Mater.
12	6	992216/R	500	16.5	zama zamak
10	10	9922110/R	500	18.7	zama zamak

9921 (Finitura zincata/ Zinc finishing)

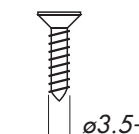

Vite non inclusa
Screw not included

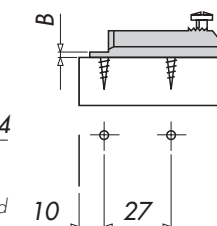

B	Cod. Art.	Conf. N° pezzi	Peso Kg	Mater.
4	992134	1000	16	zama zamak

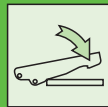

9935/LR

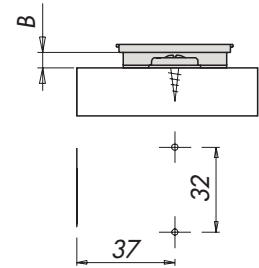
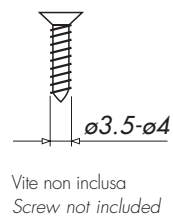

B	Cod. Art.	Conf. N° pezzi	Peso Kg	Mater.
3	993513/LR	1000	9.5	acciaio steel
4	993514/LR	1000	14	acciaio steel
6	993516/LR	1000	14.6	acciaio steel
8	993518/LR	1000	8	acciaio steel

9935/LR0

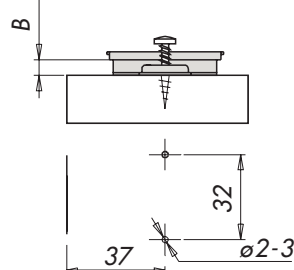
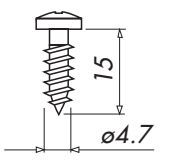
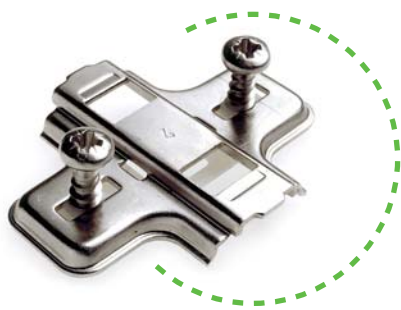

B	Cod. Art.	Conf. N° pezzi	Peso Kg	Mater.
3	993513/LR0	500	9.3	acciaio steel
4	993514/LR0	500	9.3	acciaio steel
6	993516/LR0	500	9.5	acciaio steel
8	993518/LR0	500	9.8	acciaio steel

9935/LE

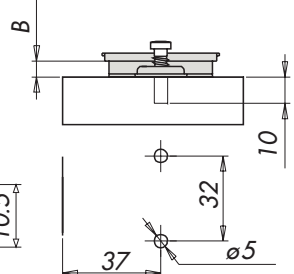
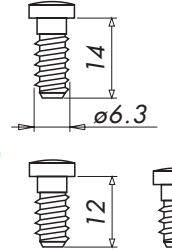
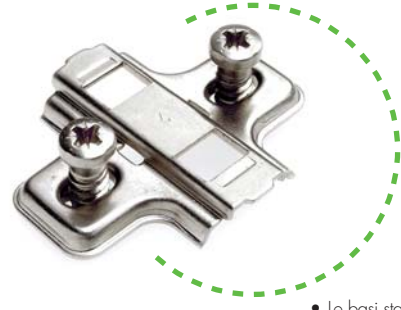

- Le basi standard sono fornite con le viti ø6.3 x 14. A richiesta sono disponibili anche con le viti altezza 12 e 10.5 mm.
- Standard mounting plates are supplied with diam. 6.3 x 14 screws. On request we can also supply them with the 12 and 10.5 mm high screws.

B	Cod. Art.	Conf. N° pezzi	Peso Kg	Mater.
3	993513/LE	500	10.4	acciaio steel
4	993514/LE	500	10.6	acciaio steel
6	993516/LE	500	10.8	acciaio steel
8	993518/LE	500	11.5	acciaio steel

9935/LR5

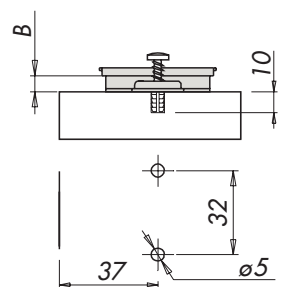
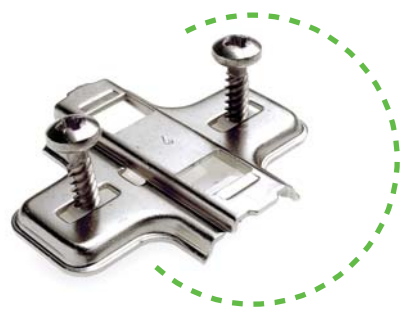

B	Cod. Art.	Conf. N° pezzi	Peso Kg	Mater.
3	993513/LR5	500	9.2	acciaio steel
4	993514/LR5	500	9.5	acciaio steel
6	993516/LR5	500	9.8	acciaio steel
8	993518/LR5	500	10.1	acciaio steel

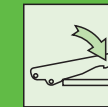

9935/LR10

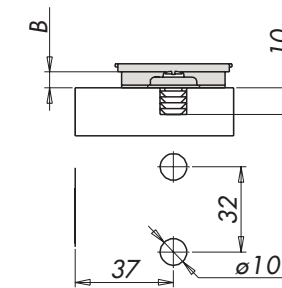

B	Cod. Art.	Conf. N° pezzi	Peso Kg	Mater.
3	993513/LR10	500	9.5	acciaio steel
4	993514/LR10	500	9.8	acciaio steel
6	993516/LR10	500	10.1	acciaio steel
8	993518/LR10	500	10.5	acciaio steel

9936/R

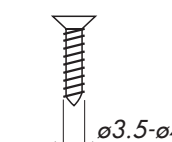

Vite non inclusa
Screw not included

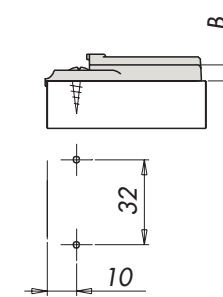

B	Cod. Art.	Conf. N° pezzi	Peso Kg	Mater.
6	993616/R	500	17	zama
10	9936110/R	500	19.6	zama

02NI130

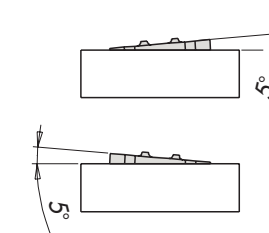
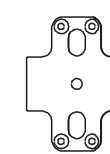
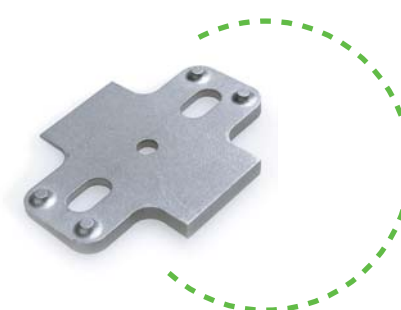

Spessore sottobase inclinato 5°
5° inclined plate

Cod. Art.	Finitura	Mater.
02NI130	grigio grey	nylon

Da utilizzare per la serie 9935/LR
Svitabile for series 9935/LR

02NH023

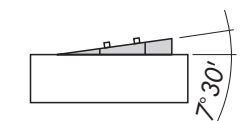
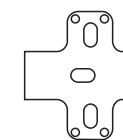

Spessore sottobase inclinato 7.5°
7.5° inclined plate

Cod. Art.	Finitura	Mater.
02NH023	nero black	nylon

Da utilizzare per la serie 9929/LR
svitabile for series 9929/LR